

# LP SERIES-General Purpose

## LP12-0.8 (12V0.8AH)

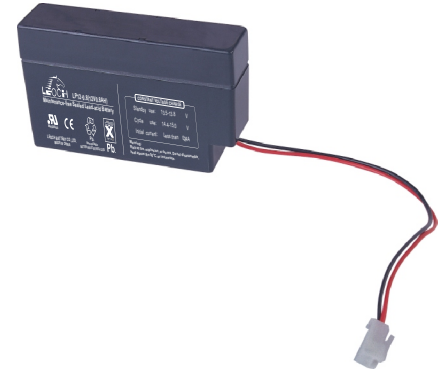

### Specification

Nominal Voltage	12V	
Nominal Capacity(20HR)	0.8AH	
Dimensions	Length	96 ± 1mm (3.78 inches)
	Width	25 ± 1mm (0.98 inches)
	Container Height	62 ± 1mm (2.44 inches)
	Total Height (with Terminal)	62 ± 1mm (2.44 inches)
Approx Weight	Approx 0.35 kg (0.77lbs)	
Terminal	/	
Container Material	ABS	
Rated Capacity	0.80 AH/0.040A	(20hr, 1.80V/cell, 25°C/77°F)
	0.74 AH/0.074A	(10hr, 1.80V/cell, 25°C/77°F)
	0.67 AH/0.134A	(5hr, 1.75V/cell, 25°C/77°F)
	0.588 AH/0.196A	(3hr, 1.75V/cell, 25°C/77°F)
	0.486 AH/0.486A	(1hr, 1.60V/cell, 25°C/77°F)
Max. Discharge Current	12A (5s)	
Internal Resistance	Approx 150mΩ	
Operating Temp. Range	Discharge	-15 ~ 50°C (5 ~ 122°F)
	Charge	0 ~ 40°C (32 ~ 104°F)
	Storage	-15 ~ 40°C (5 ~ 104°F)
Nominal Operating Temp. Range	25 ± 3°C (77 ± 5°F)	
Cycle Use	Initial Charging Current less than 0.24A. Voltage 14.4V~15.0V at 25°C(77°F)Temp. Coefficient -30mV/°C	
	Standby Use No limit on Initial Charging Current Voltage 13.5V~13.8V at 25°C(77°F)Temp. Coefficient -20mV/°C	
Capacity affected by Temperature	40°C (104°F)	103%
	25°C (77°F)	100%
	0°C (32°F)	86%
Self Discharge	Leoch LP series batteries may be stored for up to 6 months at 25°C(77°F) and then a freshening charge is required. For higher temperatures the time interval will be shorter.	

### Applications

- ◆ All purpose
- ◆ Uninterruptable Power Supply (UPS)
- ◆ Electric Power System (EPS)
- ◆ Emergency backup power supply
- ◆ Emergency light
- ◆ Railway signal
- ◆ Aircraft signal
- ◆ Alarm and security system
- ◆ Electronic apparatus and equipment
- ◆ Communication power supply
- ◆ DC power supply
- ◆ Auto control system



### Constant Current Discharge (Amperes) at 25 °C (77°F)

F.V/Time	5min	10min	15min	20min	30min	45min	1h	2h	3h	4h	5h	6h	8h	10h	20h
1.85V/cell	1.54	1.07	0.883	0.766	0.614	0.473	0.386	0.236	0.180	0.148	0.125	0.109	0.086	0.072	0.040
1.80V/cell	1.89	1.28	1.02	0.866	0.680	0.515	0.416	0.251	0.189	0.155	0.131	0.113	0.090	0.074	0.040
1.75V/cell	2.24	1.44	1.13	0.943	0.726	0.547	0.438	0.262	0.196	0.160	0.134	0.116	0.092	0.076	0.040
1.70V/cell	2.54	1.59	1.22	1.01	0.763	0.569	0.456	0.272	0.202	0.164	0.138	0.119	0.093	0.077	0.041
1.65V/cell	2.80	1.71	1.29	1.06	0.795	0.591	0.475	0.280	0.207	0.168	0.141	0.121	0.095	0.078	0.042
1.60V/cell	2.94	1.79	1.35	1.10	0.818	0.604	0.486	0.289	0.212	0.172	0.144	0.124	0.097	0.080	0.042

### Constant Power Discharge (Watts/cell) at 25 °C (77°F)

F.V/Time	5min	10min	15min	20min	30min	45min	1h	2h	3h	4h	5h	6h	8h	10h	20h
1.85V/cell	2.90	2.04	1.70	1.48	1.20	0.927	0.761	0.467	0.357	0.295	0.251	0.218	0.174	0.145	0.080
1.80V/cell	3.52	2.41	1.95	1.67	1.32	1.00	0.815	0.494	0.374	0.308	0.260	0.226	0.179	0.149	0.080
1.75V/cell	4.12	2.70	2.13	1.80	1.40	1.06	0.853	0.512	0.384	0.316	0.266	0.230	0.183	0.151	0.081
1.70V/cell	4.62	2.94	2.29	1.92	1.46	1.09	0.884	0.530	0.395	0.322	0.271	0.235	0.184	0.153	0.082
1.65V/cell	5.03	3.13	2.39	1.99	1.51	1.13	0.915	0.543	0.403	0.327	0.275	0.238	0.187	0.154	0.082
1.60V/cell	5.19	3.21	2.46	2.03	1.53	1.14	0.928	0.556	0.410	0.333	0.279	0.241	0.189	0.156	0.082

# Dimensions

## Terminal Unit: mm [inches]

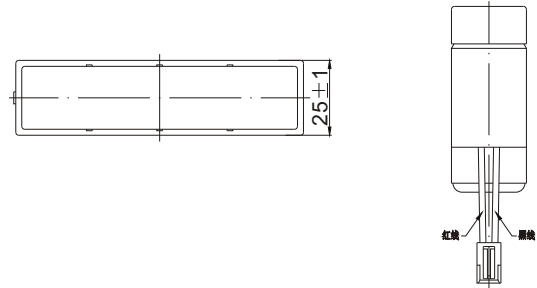
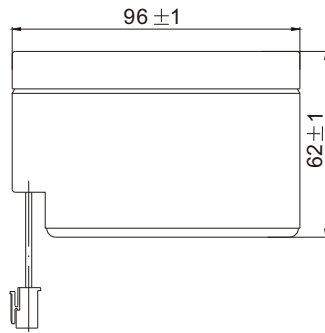
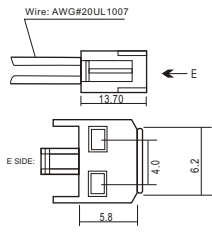

# Discharge Characteristics

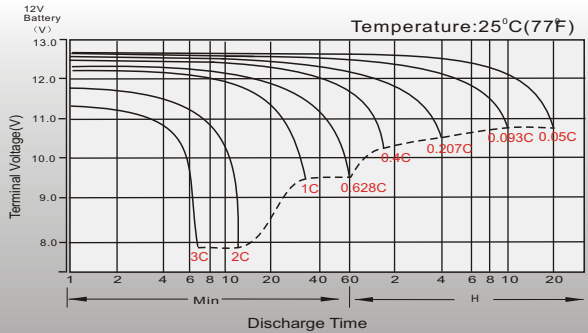

# Float Charging Characteristics

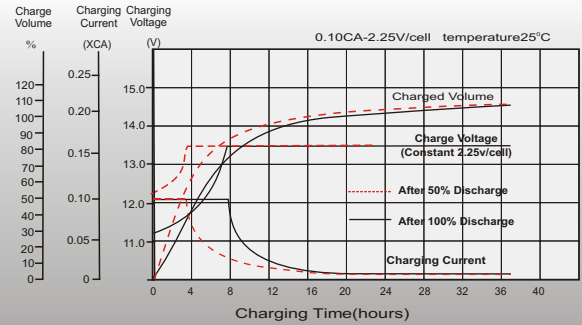

# Temperature Effects in Relation to Battery Capacity

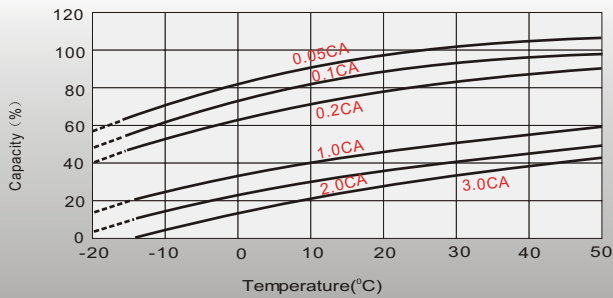

# Effect of Temperature on Long Term Float Life

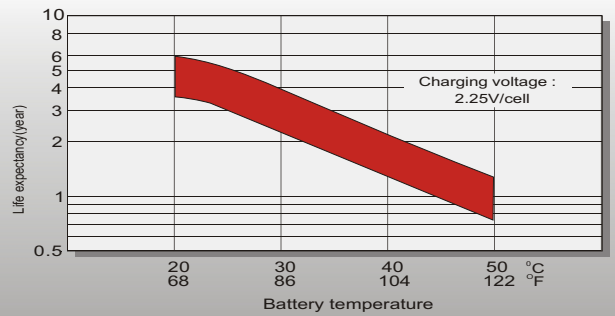

# Cycle Life in Relation to Depth of Discharge

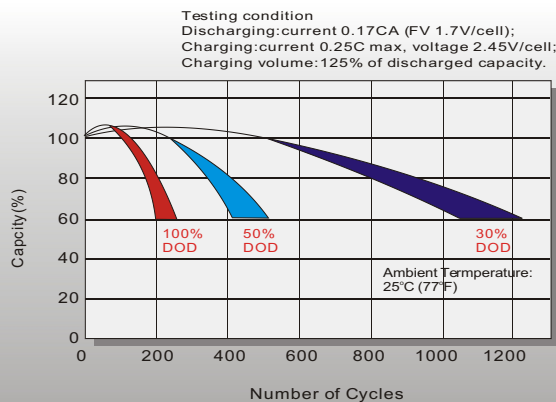

# Self Discharge Characteristics

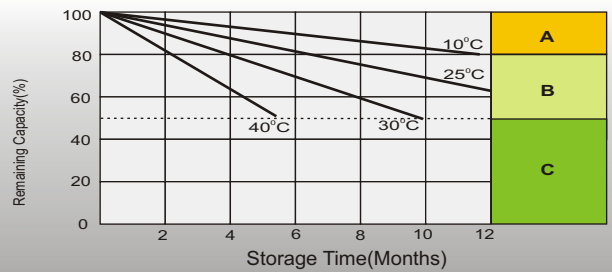

- A** No supplementary charge required (Carry out supplementary charge before use if 100% capacity is required.)
- B** Supplementary charge required before use. Optional charging way as below:  
 1. Charged for above 3 days at limited current 0.25CA and constant voltage 2.25V/cell.  
 2. Charged for above 20 hours at limited current 0.25CA and constant voltage 2.45V/cell.  
 3. Charged for 8-10 hours at limited current 0.05CA.
- C** Supplementary charge may often fail to recover the capacity. The battery should never be left standing till this is reached.

# Sales Office

**China sales office:**  
 Add: 5th Floor, Xinbaohui Bldg., Nanhai Blvd.,  
 Nanshan, Shenzhen, China. 518052  
 Tel: +86-755-86036060 (100 lines)  
 Fax: +86-755-26067269  
 E-mail: export@leoch.com  
 Http://www.leoch.com

**HongKong sales office:**  
 Add: Workshop C, 33/F, TML Tower,  
 No. 3 Hoi Shing Road, Tsuen Wan,  
 New Territories, Hong Kong  
 Tel: +852 35786666  
 Fax: +852 21170016  
 E-mail: sales.hk@leoch.com

**Singapore sales office:**  
 Add: No. 1 Tech Park Crescent,  
 Singapore 638131  
 Tel: +65 68416629  
 Fax: +65 68443210  
 Email: sales.sg@leoch.com

**North America sales office:**  
 Add: 19751 Descartes, Unit A,  
 Foothill Ranch, CA 92610, USA  
 Tel: 949-588-5853  
 Fax: 949-588-5966  
 E-mail: sales@leoch.us  
 Http://www.leoch.com

**Europe sales office:**  
 Add: 9B Wheatstone Court, Waterwells  
 Business Park, Gloucester, GL2-2AQ,  
 UK United Kingdom  
 Tel: +44(0) 1452 729428 / 1452 729696  
 Fax: +44 (0)1452-690125  
 E-mail: Sales.Europe@leoch.com